

QUICK START GUIDE

ba77020y01 02/2014



Multi 3320



a xylem brand

Multi 3320 - Contents

EN English	4
DE Deutsch.....	6
CS Český	8
DA Dansk	10
EL Ελληνικά	12
ES Español.....	14
FI Suomi	16
FR Français	18
HU Magyar	20
IT Italiano	22
JA 日本語	24
KO 한국어.....	26
NL Nederlands	28
NO Norsk	30
PL Polski.....	32
PT Português	34
RO Română	36
RU Русский	38
SK Slovenský	40
SV Svenska	42
TR Türkçe	44
ZH 中文.....	46

Multi 3320

Overview







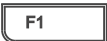

The Multi 3320 meter enables you to perform measurements (pH, conductivity, D.O.) quickly and reliably.

The Multi 3320 meter provides a maximum degree of operating comfort, reliability and measuring certainty.

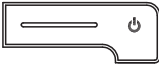
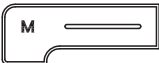
Keypad

Keys are indicated by brackets <..>.

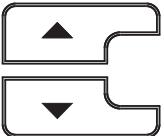
The key symbol (e.g. <ENTER>) generally indicates a short keystroke (under 2 sec). A long keystroke (approx. 2 sec) is indicated by the underscore behind the key symbol (e.g. <ENTER__>).

	<F1>: <F1__>:	Situation dependent function (is shown on the display)<F1>/ [Menu]: Opens the menu for measurement settings
	<F2>: <F2__>:	<F1__>/[Menu]: Opens the menu for system settings
	<On/Off>:	Switches the meter on or off
	<M>:	Selects the measured parameter
	<CAL>: <CAL__>:	Calls up the calibration procedure Displays the calibration data
	<STO>: <STO__>:	Saves a measured value manually Opens the menu for the automatic save function
	<RCL>: <RCL__>:	Displays the manually stored measured values Displays the automatically stored measured values
	<▲><▼>:	Menu control, navigation
	<ENTER>: <ENTER__>:	Opens the menu for measurement settings / confirms entries Opens the menu for system settings
	<AR>:	Freezes the measured value (HOLD function) Switches the AutoRead measurement on or off

Display (example: pH measurement)

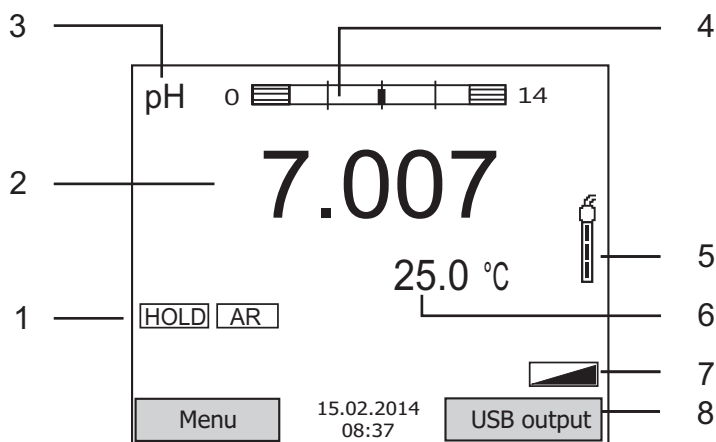

1	Status information
2	Measured value (with unit)
3	Measured parameter
4	Continuous measurement control (CMC function)
5	Sensor symbol (calibration evaluation)
6	Measured temperature (with unit)
7	Further status information
8	Softkeys and date/time

Jack field /connections

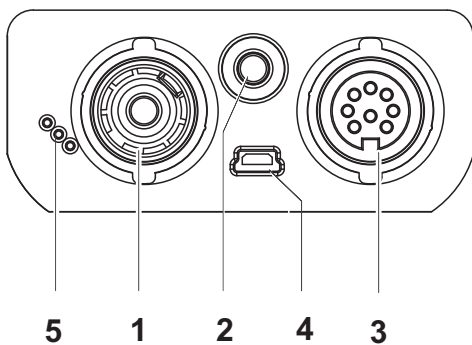

1	pH electrode
2	Temperature sensor
3	Conductivity measuring cell, D.O. sensor
4	USB B interface (device)
5	Service interface

Initial commissioning

- 1 | Insert the supplied batteries.
Make sure that the poles are in the correct position.
- 2 | Switch on the meter with the <On/Off> key.



Caution

Follow the safety instructions of the used sensors.
The operating manuals of the sensors are available on the supplied CD and on the Internet under www.WTW.com.

Multi 3320

Überblick







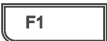

Mit dem Messgerät Multi 3320 können Sie schnell und zuverlässig Messungen (pH, Leitfähigkeit, Sauerstoff) durchführen.

Das Messgerät Multi 3320 bietet ein Höchstmaß an Bedienkomfort, Zuverlässigkeit und Messsicherheit.

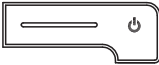
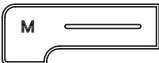
Tastenfeld

Tasten werden durch spitze Klammern <.> veranschaulicht.

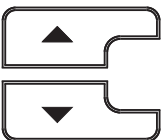
Das Tastensymbol (z. B. <ENTER>) bedeutet generell einen kurzen Tastendruck (unter 2 sec). Ein langer Tastendruck (ca. 2 sec) wird durch einen Strich hinter dem Tastensymbol (z. B. <ENTER__>) veranschaulicht.

	<F1>: <F1__>:	Situationsabhängige Funktion (wird am Display angezeigt) z. B.:
	<F2>: <F2__>:	<F1>/[Menu]: Menü für Messeinstellungen öffnen <F1__>/[Menu]: Menü für Systemeinstellungen öffnen
	<On/Off>:	Messgerät ein-/ausschalten
	<M>:	Messgröße anwählen
	<CAL>: <CAL__>:	Kalibrierverfahren aufrufen Kalibrierdaten anzeigen
	<STO>:	Messwert manuell speichern Automatische Speicherung konfigurieren und starten
	<RCL>: <RCL__>:	Manuell gespeicherte Messwerte anzeigen Automatisch gespeicherte Messwerte anzeigen
	<▲><▼>:	Menüsteuerung, Navigation
	<ENTER>: <ENTER__>:	Menü für Messeinstellungen öffnen / Eingaben bestätigen Menü für Systemeinstellungen öffnen
	<AR>:	Messwert einfrieren (HOLD - Funktion) AutoRead-Messung ein-/ausschalten

Display (Beispiel: pH-Messung)

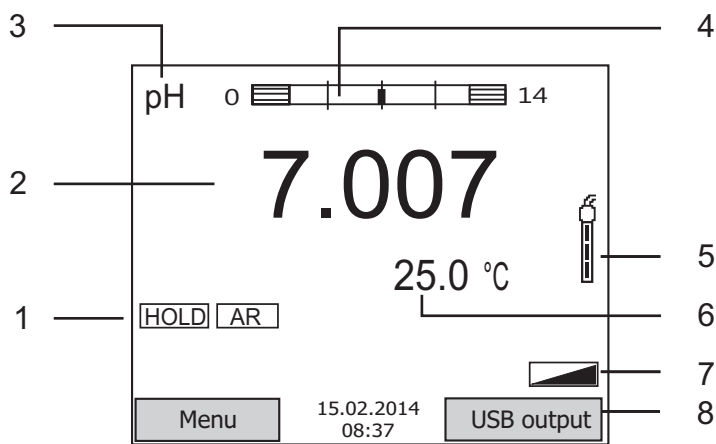

1	Statusinformationen
2	Messwert (mit Einheit)
3	Messgröße
4	Kontinuierliche Messwertkontrolle (CMC-Funktion)
5	Sensorsymbol (Kalibrierbewertung)
6	Temperaturmesswert (mit Einheit)
7	Weitere Statusinformationen
8	Softkeys und Datum/Uhrzeit

Buchsenfeld /Anschlüsse

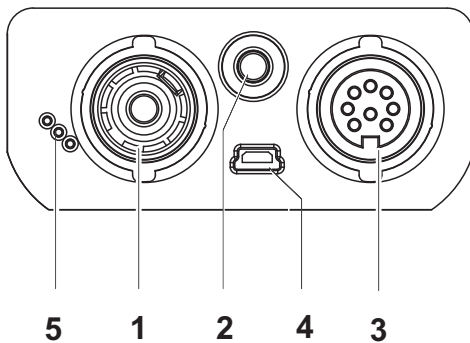

1	pH-Elektrode
2	Temperaturmessfühler
3	Leitfähigkeitsmesszelle, Sauerstoffsensoren
4	USB-B-Schnittstelle (Device)
5	Service-Schnittstelle

Erst-
inbetriebnahme

- 1 Die mitgelieferten Batterien einlegen. Achten Sie dabei auf die richtige Polung.
- 2 Messgerät mit der Taste <On/Off> einschalten.



Vorsicht

Beachten Sie die Sicherheitshinweise zu den verwendeten Sensoren. Die Bedienungsanleitungen zu den Sensoren finden Sie auf der mitgelieferten CD und im Internet unter www.WTW.com.

Multi 3320

Přehled







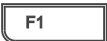

Měřičem Multi 3320 můžete rychle a spolehlivě měřit (pH, vodivost, rozpuštěný kyslík).

Měřič Multi 3320 nabízí v maximální míře komfort obsluhy a ovládání, spolehlivost a bezpečnost měření.

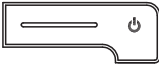
Tlačítka

Tlačítka jsou označena špičatými závorkami <.>.

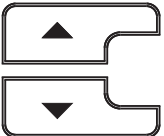
Tlačítkový symbol (např. <ENTER>) všeobecně znamená krátké stisknutí tlačítka (kratší než 2 s). Dlouhé stisknutí tlačítka (cca 2 s) je znázorněno podtržítkem za symbolem tlačítka (např. <ENTER__>).

	<F1>: <F1__>: <F2>: <F2__>:	Situačně závislá funkce (indikuje se na displeji), např.: <F1>/[Menu]: Otevření nabídky měřických nastavení <F1__>/[Menu]: Otevření nabídky systémových nastavení
		
	<On/Off (Zap/ Vyp)>:	Zapnutí/vypnutí přístroje
	<M>:	Volba měřené veličiny
	<CAL>: <CAL__>:	Vyvolání kalibrace Zobrazení kalibračních údajů
	<STO>: <STO__>:	Ruční uložení naměřené hodnoty Nakonfigurovat a spustit automatické ukládání
	<RCL>: <RCL__>:	Zobrazení ručně uložených naměřených hodnot
	<▲><▼>:	Nastavování a navigace v nabídkách
	<ENTER>: <ENTER__>:	Otevření nabídky měřických nastavení / potvrzení zadání Otevření nabídky systémových nastavení
	<AR>:	Zmrazení naměřené hodnoty (funkce HOLD) Zapnutí / vypnutí měření s automatickým odečítáním

Displej (příklad: měření pH)

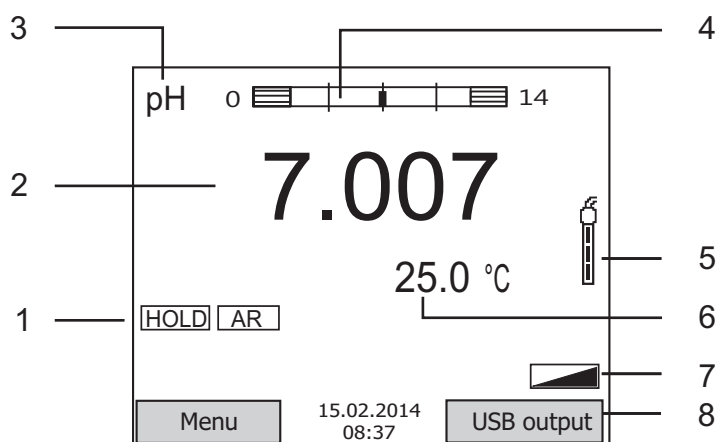

1	Stavové informace
2	Naměřená hodnota (s jednotkou)
3	Měrná veličina
4	Nepřetržitá kontrola měřené veličiny (funkce CMC)
5	Symbol čidla (vyhodnocení kalibrace)
6	Teplota měření (s jednotkou)
7	Další stavové informace
8	Programovatelná funkční tlačítka a datum/čas

Zásuvky / přípojky

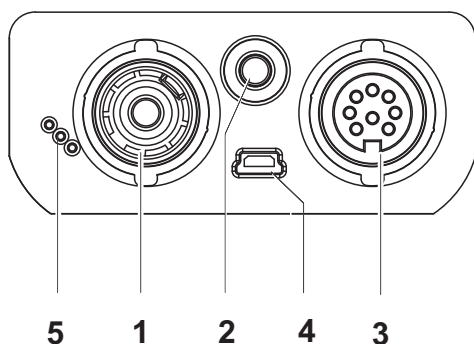

1	Elektroda pH
2	Teplotní čidlo
3	Článek na měření vodivosti, Snímač na měření rozpuštěného kyslíku
4	Rozhraní USB-B (přístroj)
5	Servisní rozhraní

První uvedení do provozu

- 1 Vložte přiložené baterie. Dbejte přitom na správnou polaritu.
- 2 Zapněte měřicí přístroj tlačítkem <On/Off (Zap/Vyp)> .

**Pozor**

Dodržujte bezpečnostní pokyny pro použitá čidla.

Návody k obsluze čidel naleznete na přiloženém CD a na internetu na adrese www.WTW.com.







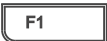

Multi 3320

Oversigt

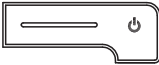
Med dette måleapparat Multi 3320 kan du hurtigt foretage pålidelige målinger (pH, Ledeevne, Oxygen).
Måleapparatet Multi 3320 giver den højest tænkelige betjeningskomfort, driftssikkerhed og målenøjagtighed.

Tastefelt

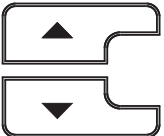
Tasterne vises med spidse klammer <.>.
Tastesymbolet (f.eks. <ENTER>) betyder generelt et kort tastetryk (mindre end 2 sek.). Et langt tastetryk (ca. 2 sek.) vises med en streg efter tastesymbolet (f.eks. <ENTER__>).

	<F1>: <F1__>:	Situationsafhængig funktion (vises på displayet) f.eks.: <F1>/[Menu]: Åbn menuen til måleindstillinger <F1__>/[Menu]: Åbn menuen til systemindstillinger
	<F2>: <F2__>:	
	<On/Off>:	Aktivering/deaktivering af måler
	<M>:	Vælg målestørrelse
	<CAL>: <CAL__>:	Hent kalibreringsmetoder Vis kalibreringsdata
	<STO>: <STO__>:	Gem måleværdien manuelt Konfigurer og start automatisk lagring
	<RCL>: <RCL__>:	Vis manuelt gemte måleværdier Vis automatisk gemte måleværdier
	<▲><▼>:	Menustyring, Navigation
	<ENTER>: <ENTER__>:	Åbn menuen til måleindstillinger/bekræft indtastning Åbn menuen til systemindstillinger
	<AR>:	Frys måleværdi (HOLD - funktion) Aktivér/deaktiver AutoRead-måling

Display (eksempel: pH-måling)

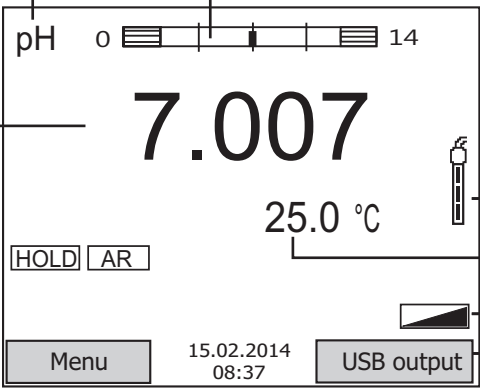
3		4	1	Statusinformationer
2		2	Måleværdi (med enhed)	
1	3	Målestørrelse		
	4	Kontinuerlig måleværdikontrol (CMC-funktion)		
	5	Sensorsymbol (kalibreringsvurdering)		
	6	Temperaturmåleværdi (med enhed)		
	7	Flere statusoplysninger		
	8	Genvejstaster samt dato/klokkeslæt		

Bøsningssområde/tilslutninger

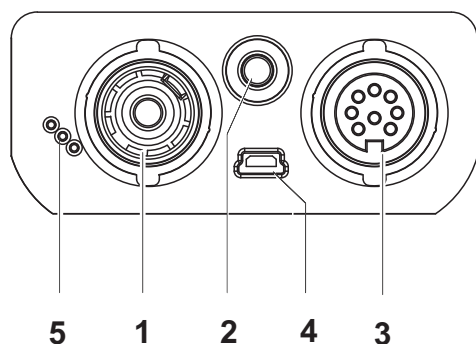

1	pH-elektrode
2	Temperaturmåleføler
3	Målecelle for ledeevne, Oxygensensor
4	USB-B-interface (Device)
5	Service-interface

Første ibrugtagning

- 1 Sæt de medfølgende batterier i. Vend i den forbindelse polerne rigtigt.
- 2 Tænd for måleren med tasten <On/Off> .



Forsigtig

Følg sikkerhedsanvisningerne til de sensorer, der skal bruges. Betjeningsvejledningen til sensorerne findes på den medfølgende cd og på internettet på adressen www.WTW.com.

Multi 3320

Επισκόπηση







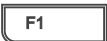

Με τη συσκευή μέτρησης Multi 3320 μπορείτε να πραγματοποιείτε γρήγορα και αξιόπιστα μετρήσεις (pH, αγωγιμότητα, οξυγόνο).

Η συσκευή μέτρησης Multi 3320 παρέχει μέγιστο βαθμό άνεσης χειρισμού, αξιοπιστίας και ασφάλειας μετρήσεων.

Πληκτρολόγιο

Τα πλήκτρα απεικονίζονται με παρενθέσεις της μορφής <.>.

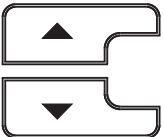
Το σύμβολο πλήκτρου (π.χ. <ENTER>) σημαίνει γενικά σύντομο πάτημα ενός πλήκτρου (διάρκειας μικρότερης των 2 δευτ.). Το παρατεταμένο πάτημα των πλήκτρων (διάρκειας 2 δευτ. περίπου) απεικονίζεται με μία παύλα μετά το σύμβολο του πλήκτρου (π.χ. <ENTER__>).

	<F1>:	Λειτουργία ανάλογα με την κατάσταση (εμφανίζεται στην οθόνη), π. χ.:
	<F1__>:	
	<F2>:	<F1>/[Menu]: Άνοιγμα μενού για τις ρυθμίσεις της μέτρησης
	<F2__>:	<F1__>/[Menu]: Άνοιγμα μενού για τις ρυθμίσεις συστήματος
	<On/Off>:	Ενεργοποίηση/απενεργοποίηση συσκευής μέτρησης
	<M>:	Επιλογή μετρούμενου μεγέθους
	<CAL>:	Ανάκληση μεθόδου βαθμονόμησης από τη μνήμη
	<CAL__>:	Εμφάνιση δεδομένων βαθμονόμησης
	<STO>:	Μη αυτόματη αποθήκευση της τιμής μέτρησης
	<STO__>:	Διαμόρφωση και έναρξη αυτόματης αποθήκευσης
	<RCL>:	Εμφάνιση τιμών μέτρησης που αποθηκεύτηκαν μη αυτόματα
	<RCL__>:	Εμφάνιση τιμών μέτρησης που αποθηκεύτηκαν αυτόματα
	<▲><▼>:	Έλεγχος μενού, πλοήγηση
	<ENTER>:	Άνοιγμα μενού για τις ρυθμίσεις της μέτρησης / Επιβεβαίωση εισαγωγής τιμών
	<ENTER__>:	Άνοιγμα μενού για τις ρυθμίσεις συστήματος
	<AR>:	'Πάγωμα' τιμής μέτρησης (λειτουργία HOLD) Ενεργοποίηση/απενεργοποίηση μέτρησης AutoRead

Οθόνη (παράδειγμα: μέτρηση pH)

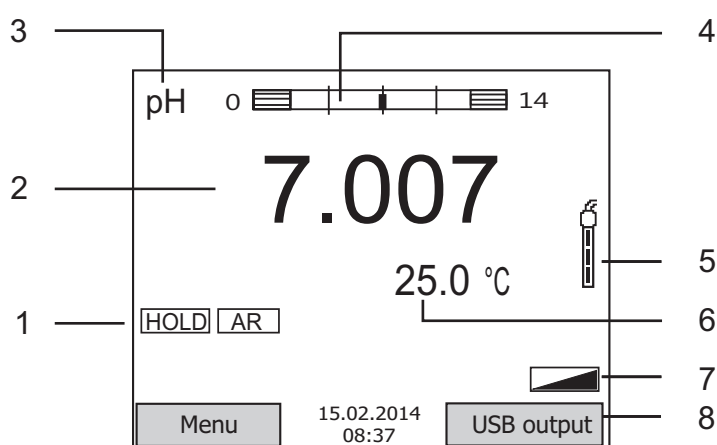

1	Πληροφορίες κατάστασης
2	Τιμή μέτρησης (με μονάδα)
3	Μετρούμενο μέγεθος
4	Συνεχόμενος έλεγχος τιμών μέτρησης (λειτουργία CMC)
5	Σύμβολο αισθητήρα (αξιολόγηση βαθμονόμησης)
6	Τιμή μέτρησης θερμοκρασίας (με μονάδα)
7	Περαιτέρω πληροφορίες κατάστασης
8	Προγραμματιζόμενα πλήκτρα και

Πεδίο υποδοχών /συνδέσεις

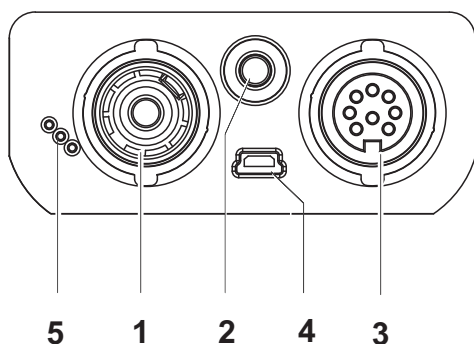

1	Ηλεκτρόδιο pH
2	Αισθητήρας μέτρησης θερμοκρασίας
3	Κυψελίδα μέτρησης αγωγιμότητας, Αισθητήρας οξυγόνου
4	Θύρα USB-B (Device)
5	Υποδοχή διασύνδεσης σέρβις

Πρώτη έναρξη λειτουργίας

- 1 Τοποθετήστε τις παρεχόμενες μπαταρίες. Προσέξτε τη σωστή πολικότητα.
- 2 Ενεργοποιήστε τη συσκευή μέτρησης με το πλήκτρο **<On/Off>** .



Προσοχή

Λάβετε υπόψη τις υποδείξεις ασφαλείας για τους χρησιμοποιούμενους αισθητήρες. Μπορείτε να βρείτε τις οδηγίες χρήσης των αισθητήρων στο παρεχόμενο CD και στο Internet, στην ιστοσελίδα www.WTW.com.

Multi 3320

Sumario







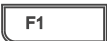

Con el instrumento de medición Multi 3320 puede Ud. efectuar mediciones de (pH, conductibilidad, oxígeno) de manera rápida y fidedigna.

El instrumento de medición Multi 3320 ofrece máxima comodidad de empleo, confiabilidad y seguridad de medición.

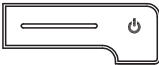
Teclado

Las teclas están identificadas por paréntesis angulares <.> .

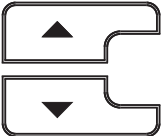
El símbolo de tecla (por ejemplo <ENTER>) significa por lo general una breve presión (menos de 2 segundos). Si se ha de oprimir la tecla prolongadamente (2 segundos, aprox.), se ha representado por una raya a continuación del símbolo de la tecla (por ejemplo <ENTER__>).

	<F1>:	Situación dependiente de la situación momentánea (aparece indicada en el display) por ejemplo: <F1>/[Menu]: Acceder al menú para la configuración de medición <F1__>/[Menu]: Acceder l menú para la configuración del sistema
	<F1__>:	
	<F2>:	
	<F2__>:	
	<On/Off>:	Prender/apagar instrumento
	<M>:	Seleccionar la unidad de medición
	<CAL>:	Llamar el procedimientos de calibración
	<CAL__>:	Mostrar los datos de calibración
	<STO>:	Archivar en memoria manualmente el valor medido
	<STO__>:	Configurar el almacenamiento automático e iniciar la sesión
	<RCL>:	Visualizar los valores medidos guardados manualmente
	<RCL__>:	Visualizar los valores medidos guardados automáticamente
	<▲><▼>:	Control del menú, navegación
	<ENTER>:	Acceder al menú para la configuración de medición / Confirmar los datos ingresados
	<ENTER__>:	Acceder al menú para la configuración del sistema
	<AR>:	Congelar el valor medido (función HOLD) Prender/apagar la medición AutoRead

Display (ejemplo: medición del pH)

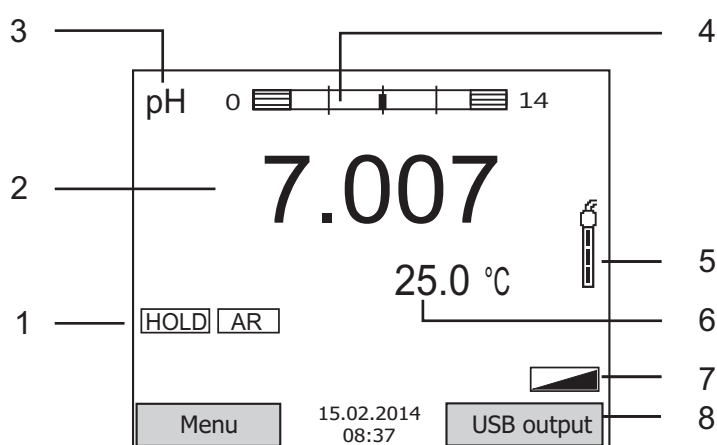

1	Información sobre el estado actual
2	Valor medido (con unidad)
3	Parámetro
4	Control permanente de los valores medidos (función CMC)
5	Símbolo del sensor (evaluación de la calibración)
6	Temperatura medida (con unidad)
7	Más información sobre el estado actual
8	Softkeys y fecha / hora

Conexiones varias /conexiones

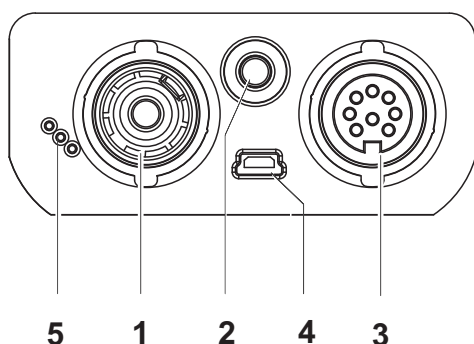

1	Electrodo pH
2	Sensor térmico
3	Célula conductímetra, Conectar el sensor de oxígeno
4	Interfase USB-B (device)
5	Interfase de servicio

Primera puesta en funcionamiento

- Colocar las pilas incluidas. Al colocarlas, preste atención a la polaridad correcta.
- Prender el instrumento de medición con la tecla <On/Off>.



Atención

Tenga presente las instrucciones de seguridad de los sensores utilizados. Las instrucciones de empleo de los sensores se encuentran en el CD adjunto o bien, en el internet bajo www.WTW.com.

Multi 3320









Yleiskuvaus

Mittalaitteella Multi 3320 voit suorittaa nopeasti ja luotettavasti mittauksia (pH, johtavuus, happi).
Mittalaite Multi 3320 tarjoaa enimmäismäärän käyttömukavuutta, luotettavuutta ja mittaustuloksen varmuutta.

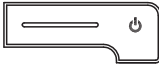
Näppäimistö

Painikkeet havainnollistetaan hakasuluilla <.>.

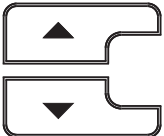
Painikkeen symboli (esim. <ENTER>) tarkoittaa yleensä lyhyttä painikkeen painamista (alle 2 s.). Pitkä painikkeen painaminen (n. 2 s.) havainnollistetaan painikkeen symbolin takana olevalla viivalla (esim. <ENTER__>).

	<F1>: <F1__>:	Tilanteesta riippuva toiminto (näytetään näytössä) esim. : <F1>/[Menu]: Avaa mittausasetusten valikko <F1__>/[Menu]: Avaa järjestelmäasetusten valikko
	<F2>: <F2__>:	
	<On/Off>:	Kytke mittauslaite päälle/pois
	<M>:	Valitse mittaussuure
	<CAL>: <CAL__>:	Hae kalibrointimenetelmä Näytä kalibrointitiedot
	<STO>: <STO__>:	Tallenna mittausarvo manuaalisesti Konfiguroi ja käynnistä automaattinen tallennus
	<RCL>: <RCL__>:	Näytä manuaalisesti tallennettu mittausarvo Näytä manuaalisesti tallennettu mittausarvo
	<▲><▼>:	Valintaohjaus, navigointi
	<ENTER>: <ENTER__>:	Avaa mittausasetusten valikko / vahvista tallennukset Avaa järjestelmäasetusten valikko
	<AR>:	Jäädytä mittausarvo (HOLD - toiminto) Kytke AutoRead-mittaus päälle/pois päältä

Näyttö (esimerkki: pH-mittaus)

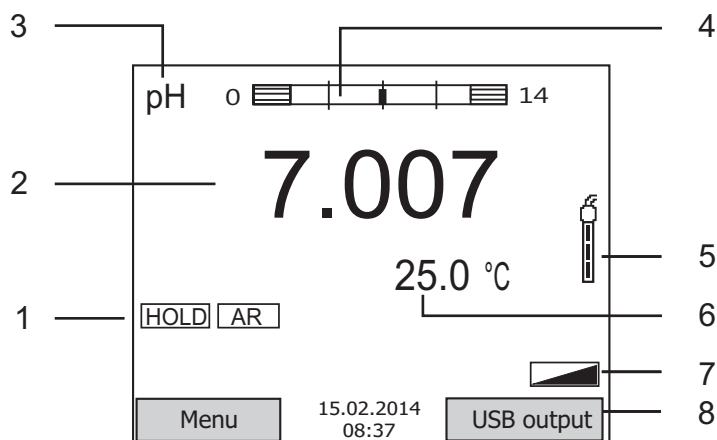

1	Tilatiedot
2	Mittausarvo (yksiköllä)
3	Mittaussuure
4	Jatkuva mittausarvon valvonta (CMC-toiminto)
5	Anturin symboli (kalibroinnin analyysi)
6	Lämpötilamittausarvo (yksiköllä)
7	Lisätilatiedot
8	Järjestelmäavaimet ja päivämäärä/ kellonaika

Pistokekenttä /liitännät

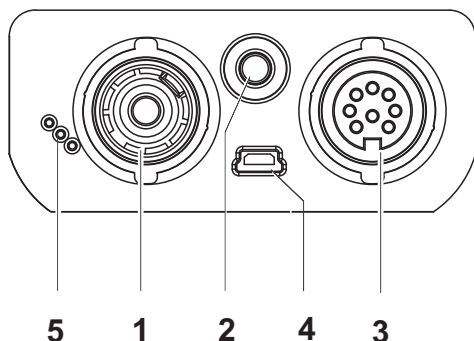

1	pH-elektrodi
2	Lämpötilamittausanturi
3	Johtavuuden mittauksen valokenno, Happianturi
4	USB-B-liitäntä (laite)
5	Huoltoliitäntä

Ensikäyttöönotto

- 1 Laita mukana toimitetut paristot sisään. Huomioi tällöin oikea napaisuus.
- 2 Kytke mittauslaite päälle painikkeella <On/Off> .



Varo

Noudata käytettävien antureiden turvallisuusohjeita. Antureiden käyttöohjeet löytyvät mukana toimitetulta CD:ltä ja internetistä osoitteesta www.WTW.com.

Multi 3320

Vue d'ensemble







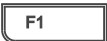

L'appareil de mesure Multi 3320 permet d'effectuer des mesures rapides et fiables (pH, conductivité, oxygène).

L'appareil de mesure Multi 3320 offre un maximum de confort de service, de fiabilité et de sécurité de mesure.

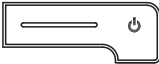
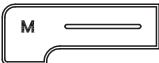
Clavier

Les touches sont symbolisées par des parenthèses pointues <.> .

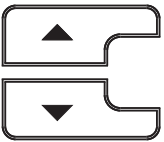
Le symbole de touche (p. ex. <ENTER>) signifie généralement qu'il faut exercer une pression brève (moins de 2 sec). La pression longue (env. 2 sec) est symbolisée par un tiret suivant le symbole de touche (p. ex. <ENTER__>).

	<F1>:	Fonction dépendante de la situation (s'affiche à l'écran) p.
	<F1__>:	ex.:
	<F2>:	<F1>/[Menu]: ouverture du menu pour réglages de mesure
	<F2__>:	<F1__>/[Menu]: ouverture du menu pour réglages système
	<On/Off>:	Allumer/éteindre l'appareil de mesure
	<M>:	Sélection de la grandeur de mesure
	<CAL>:	Appel de la procédure de calibration
	<CAL__>:	Afficher les données de calibration
	<STO>:	Enregistrement manuel de la valeur de mesure
	<STO__>:	Configuration et démarrage de l'enregistrement automatique
	<RCL>:	Affichage des valeurs de mesure enregistrées
	<RCL__>:	Affichage des valeurs de mesure enregistrées automatiquement
	<▲><▼>:	Commande par menu, navigation
	<ENTER>:	Ouverture du menu pour réglages de mesure / confirmation des entrées
	<ENTER__>:	Ouverture du menu pour réglages système
	<AR>:	Gel de la valeur de mesure (fonction HOLD) Désactivation de la mesure AutoRead

Visuel (exemple: mesure de pH)

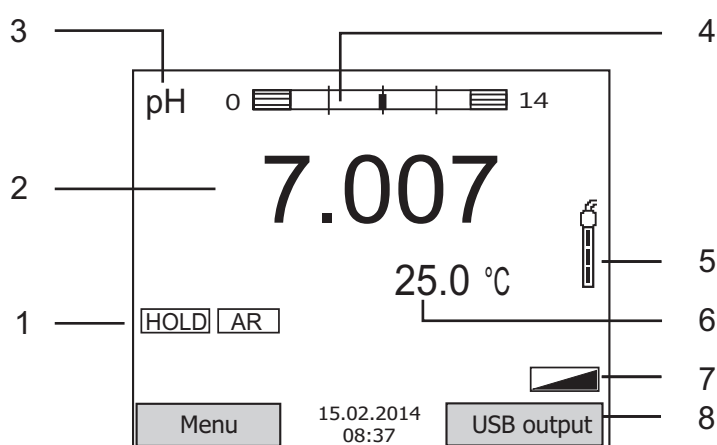

1	Informations d'état
2	Valeur mesurée (avec unité)
3	Grandeur de mesure
4	Contrôle continu de la valeur de mesure (fonction CMC)
5	Symbole de sonde (évaluation de la calibration)
6	Valeur de mesure de la température (avec unité)
7	Autres informations d'état
8	Softkeys et date/heure

Connexions /raccordements

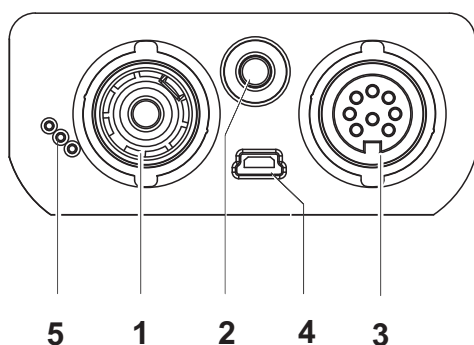

1	Electrode pH
2	Sonde de mesure de la température
3	Cellule de mesure de la conductivité, Sonde à oxygène
4	Interface USB-B (Device)
5	Interface de service

Première mise en service

- 1 Mettre en place les piles jointes à la livraison. Ce faisant, veiller à la polarité correcte.
- 2 Allumer l'appareil de mesure en appuyant sur la touche <On/Off>.

**Attention**

Veillez respecter les consignes de sécurité relatives aux sondes utilisées. Vous trouvez les modes d'emploi relatifs aux sondes sur le CD joint à la livraison et sur Internet à l'adresse www.WTW.com.

Multi 3320

Áttekintés









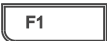

A Multi 3320 típusú műszerrel gyorsan és megbízhatóan végezhető a mérések (pH, vezetőképesség, oxigén).

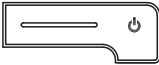
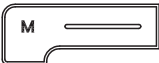
A Multi 3320 műszer a legmagasabb fokú kezelési kényelmet és megbízhatóságot nyújtja, és a legbiztosabb méréseket teszi lehetővé.

A gombok mezője

A gombokat csúcsos zárójelek <.> emelik ki.

A gomb szimbóluma (pl. <ENTER>) általában a gomb rövid (2 másodpercnél rövidebb) idejű lenyomását jelenti. A gomb hosszú idejű (kb. 2 másodpercig tartó) lenyomására a gomb szimbóluma utáni vonás (pl. <ENTER_>) utal.

	<F1>:	Helyzetfüggő (a kijelzőn megjelenített) funkció, pl.:
	<F1_>:	<F1>/[Menu]: A mérési beállítások menüjének megnyitása
	<F2>:	<F1_>/[Menu]: A rendszerbeállítások menüjének megnyitása
	<F2_>:	
	<On/Off>:	A mérőműszer ki-/bekapcsolása
	<M>:	A mérendő mennyiség megválasztása
	<CAL>:	A kalibrálási eljárás behívása
	<CAL_>:	A kalibrálási adatok kijelzése
	<STO>:	A mért érték manuális mentése
	<STO_>:	Automatikus mentés konfigurálása és indítása
	<RCL>:	A manuálisan mentett mérési értékek megjelenítése
	<RCL_>:	Az automatikusan mentett mérési értékek megjelenítése
	<▲><▼>:	Menüvezérlés, navigáció
		
	<ENTER>:	A mérési beállítások menüjének megnyitása / A bevitt adatok nyugtázása
	<ENTER_>:	A rendszerbeállítások menüjének megnyitása
	<AR>:	A mért érték befagyasztása (HOLD funkció) AutoRead-mérés ki-/bekapcsolása

Kijelző (példa: pH-mérés)

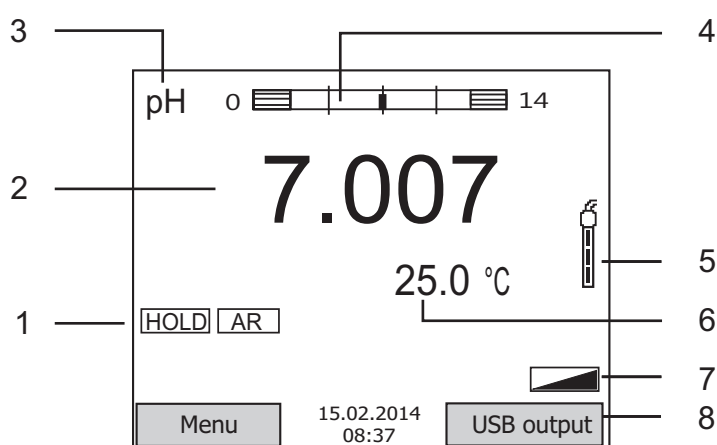

1	Állapotinformációk
2	Mért érték (mértékegységgel)
3	Mérendő mennyiség
4	A mért érték folyamatos ellenőrzése (CMC-funkció)
5	Az érzékelő jele (kalibráció kiértékelése)
6	A hőmérséklet mért értéke (mértékegységgel)
7	További állapotinformációk
8	Softkey gombok és dátum/óraidő

Foglalatok mezője /Csatlakozók

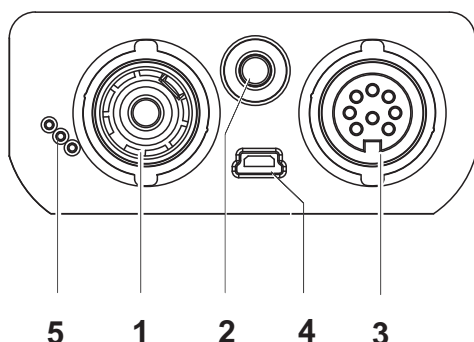

1	pH-elektroda
2	A hőmérséklet mérőérzékelője
3	Vezetőképesség-mérőcella, Oxigénérzékelő
4	'B' USB-port (Device)
5	Csatlakozási hely szervizcélokra

Első használatkor

- 1 Helyezze be a készülékkel együtt szállított elemeket. Ügyeljen a helyes polaritásra.
- 2 Kapcsolja be a mérőműszert az <On/Off> gombbal.



Figyelmeztetés

Tartsa be az alkalmazott érzékelők biztonsági utasításait. Az érzékelők kezelési utasításai megtalálhatók a készülékkel együtt kapott CD-lemezen és az interneten a www.WTW.com honlapon.

Multi 3320

Descrizione generale







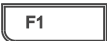

Con l'apparecchio di misurazione Multi 3320 si possono effettuare misurazioni in modo rapido e affidabile (pH, conducibilità, ossigeno).

Esso Multi 3320 offre il massimo in fatto di comfort di comando, affidabilità e sicurezza di misurazione.

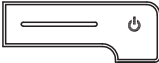
Tastiera

I tasti sono rappresentati tra parentesi angolate <.>.

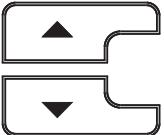
Il simbolo dei tasti (ad es. <ENTER>) indica di regola una breve pressione (inferiore a 2 secondi). La pressione prolungata (circa 2 secondi) è rappresentata da un trattino posto dopo il simbolo (ad es. <ENTER__>).

	<F1>:	Funzione a seconda della situazione (visualizzata sul display) ad es.: <F1>/[Menu]: Apertura del menu per le impostazioni della misurazione <F1__>/[Menu]: Apertura del menu per le impostazioni del sistema
	<F1__>:	
	<F2>:	
	<F2__>:	
	<ON/OFF>:	Accensione/spegnimento dello strumento di misurazione
	<M>:	Selezione dell'unità di misurazione
	<CAL>:	Richiamo della procedura di calibrazione Visualizzazione dei dati di calibrazione
	<CAL__>:	
	<STO>:	Memorizzazione manuale del valore della misurazione Configurazione e avvio della memorizzazione automatica
	<STO__>:	
	<RCL>:	Visualizzazione dei valori di misurazione memorizzati manualmente Visualizzazione dei valori di misurazione memorizzati automaticamente
	<RCL__>:	
	<▲><▼>:	Gestione menu, navigazione
	<ENTER>:	Apertura del menu per le impostazioni della misurazione / conferma immissioni Apertura del menu per le impostazioni del sistema
	<ENTER__>:	
	<AR>:	Blocco del valore di misurazione (funzione HOLD) Inserimento/disinserimento della misurazione AutoRead

Display (ad esempio: misurazione pH)

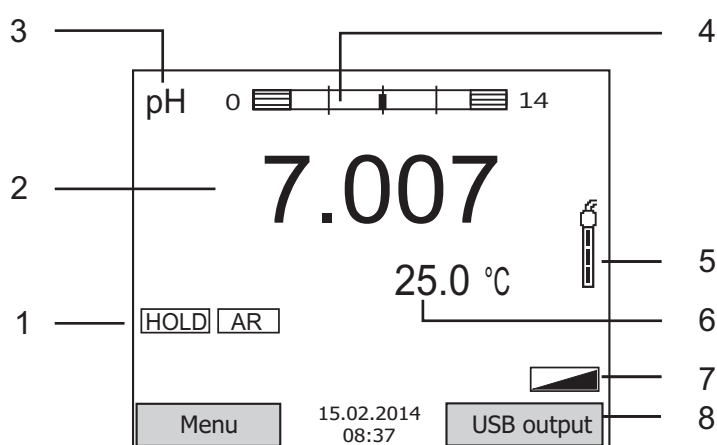

1	Informazioni di stato
2	Valore di misurazione (con unità)
3	Unità di misurazione
4	Continuo controllo dei valori di misurazione (funzione CMC)
5	Icona del sensore (valutazione della calibrazione)
6	Valore di misurazione della temperatura (con unità)
7	Altre informazioni di stato
8	Softkey e data/ora

Pannello prese /allacciamenti

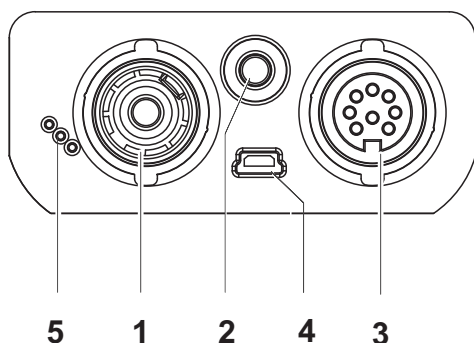

1	Elettrodo pH
2	Sensore di temperatura
3	Cella di misurazione conducibilità, Sensore ossigeno
4	Interfaccia USB-B (Device)
5	Interfaccia di servizio

Prima messa in funzione

- 1 | Introdurre le batterie fornite in dotazione, prestando attenzione alla corretta polarità.
- 2 | Accendere lo strumento di misurazione con il tasto <ON/OFF>.

**Attenzione**

Osservare le avvertenze di sicurezza relative ai sensori utilizzati. Le istruzioni per l'uso dei sensori sono contenute nel CD fornito in dotazione oppure si trovano alla pagina www.WTW.com.

Multi 3320

概要







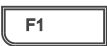

この測定器 Multi 3320 は、すばやく正確に（pH、伝導度、酸素）を測定することができます。

測定器 Multi 3320 は、最大限の操作快適性、信頼性および測定確実性を提供します。

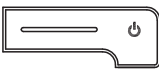
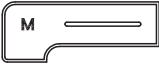
キーパッド

個々のキー名は山括弧 <.> に入れて表記されています。

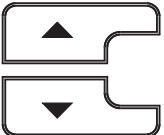
キーシンボル（例：<ENTER>）は原則として短く押すものとします（2秒未満）。長く押す（約2秒）場合は、キーシンボルの後ろにアンダーバーを付けています（例：<ENTER__>）。

	<F1>:	状況に応じた機能（ディスプレイに表示）
	<F1__>:	例：
	<F2>:	<F1>/[Menu]: 測定設定メニューを開く
	<F2__>:	<F1__>/[Menu]: システム設定メニューを開く
	<On/Off>:	測定器をオン / オフする
	<M>:	測定量を選択する
	<CAL>:	キャリブレーション手順を呼び出す
	<CAL__>:	キャリブレーションデータを表示する
	<STO>:	測定値を手動保存する
	<RCL>:	手動保存した測定値を表示する
	<▲><▼>:	メニュー制御、ナビゲーション
	<ENTER>:	測定設定メニューを開く / 入力を確認する
	<ENTER__>:	システム設定メニューを開く
	<AR>:	測定値をフリーズする（HOLD機能） AutoRead 測定をオン / オフする

ディスプレイ（例：pH 測定）

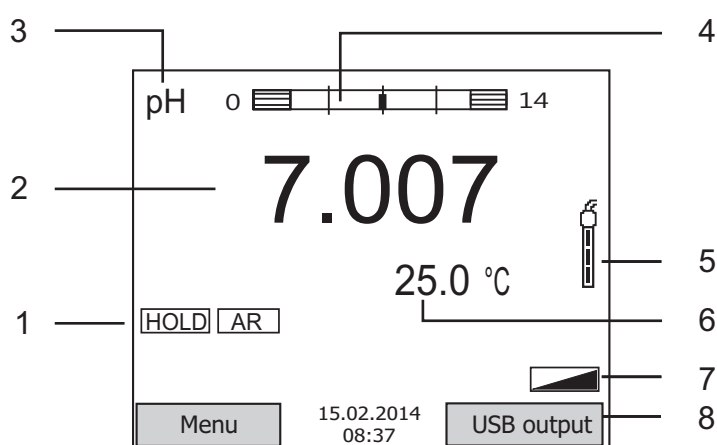

1	ステータス情報
2	測定値（単位付き）
3	測定量
4	連続測定値点検（CMC 機能）
5	センサーシンボル （キャリブレーション評価）
6	温度測定値（単位付き）
7	その他のステータス情報
8	ソフトキーおよび日付 / 時刻

ソケットエリア / 接続部

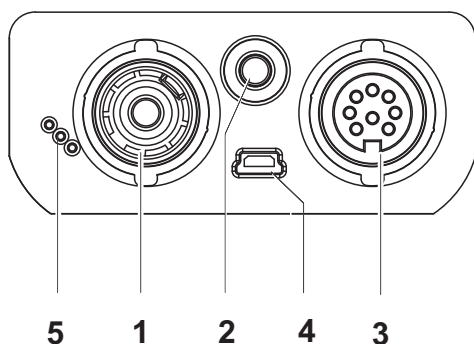

1	pH 電極
2	温度センサー
3	伝導度測定セル，酸素センサー
4	USB-B インターフェース（デバイス）
5	サービスインターフェース

初回使用時

- 1 同梱の電池を装着します。
その際、プラス極 / マイナス極を確認して正しく装着してください。
- 2 測定器をキー <On/Off> でオンにします。



注意

使用しているセンサーの安全に関する注意事項を順守してください。
センサーの取扱説明書は、同梱の CD に収録されています。
また [www.WTW.com] で閲覧することもできます。







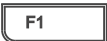

Multi 3320

개요

측정기 Multi 3320 을 이용하면 빠르고 정확한 측정 (pH, 전도성, 산소) 이 가능합니다.
 측정기 Multi 3320 은 뛰어난 조작 편의성과 신뢰성, 그리고 정확성을 자랑합니다.

키패드

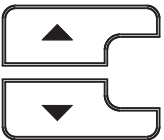
키는 꺾쇠 괄호 <.> 로 표시됩니다.
 키 심볼 (예: <ENTER>)은 일반적으로 짧게 누르는 것을 의미합니다(2 초이내). 길게 눌러야 하는 경우 (약 2 초) 에는 키 심볼 뒤에 밑줄이 표시됩니다 (예: <ENTER__>).

	<F1>: <F1__>: <F2>: <F2__>:	상황 관련 기능 (디스플레이에 표시됨) 예 : <F1>/[Menu]: 측정 설정을 위한 메뉴 열기 <F1__>/[Menu]: 시스템 설정을 위한 메뉴 열기
	<On/Off>:	측정기 켜기 / 끄기
	<M>:	측정량 선택하기
	<CAL>: <CAL__>:	캘리브레이션 절차 불러오기 캘리브레이션 데이터 표시하기
	<STO>: <STO__>:	측정값 수동으로 저장하기 자동 저장 설정하고 시작하기
	<RCL>: <RCL__>:	수동으로 저장한 측정값 표시하기 자동으로 저장된 측정값 표시하기
	<▲><▼>:	메뉴 조작, 방향 설정
	<ENTER>: <ENTER__>:	측정 설정을 위한 메뉴 열기 / 입력 확인하기 시스템 설정을 위한 메뉴 열기
	<AR>:	측정값 정지시키기 (HOLD - 기능) AutoRead- 측정 켜기 / 끄기

디스플레이 (예 : pH- 측정)

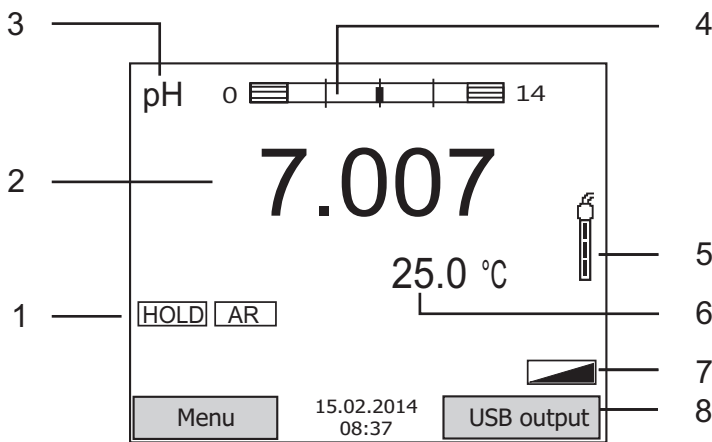

1	상태 정보
2	측정값 (단위 포함)
3	측정량
4	지속적 측정값 감시 (CMC- 기능)
5	센서 심볼 (캘리브레이션 평가)
6	온도 측정값 (단위 포함)
7	기타 상태 정보
8	소프트키 및 날짜 / 시간

소켓패널 / 연결포트

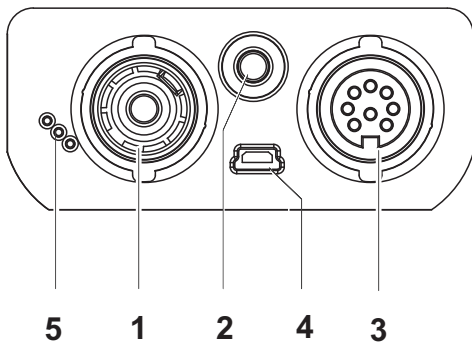

1	pH 전극
2	온도 측정기
3	전도성 측정셀, 산소 센서
4	USB-B- 인터페이스 (Device)
5	서비스 인터페이스

최초 사용

- 1 함께 제공되는 배터리를 삽입하십시오 .
이때 올바른 극성에 유의하십시오 .
- 2 <On/Off> 키를 눌러 측정기를 켜십시오 .



주의

사용된 센서의 주의사항에 유의하십시오 .
센서에 관한 사용설명서는 함께 제공되는 CD 또는 홈페이지
www.WTW.com 에서 찾아볼 수 있습니다 .

Multi 3320

Overzicht







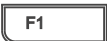

Met het meetapparaat Multi 3320 kunt u snel en betrouwbaar metingen (pH, geleidingsvermogen, zuurstof) uitvoeren.

Het meetapparaat Multi 3320 biedt een maximum aan bedieningscomfort, betrouwbaarheid en meetzekerheid.

Keypad

Toetsen worden door puntige haakjes <.> aanschouwelijk gemaakt.

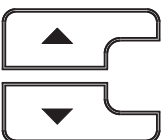
Het toetssymbool (bijv. <ENTER>) betekent over het algemeen een korte druk op de toets (korter dan 2 sec). Een langere druk op de toets (ca. 2 sec) wordt door een streep achter het toetssymbool (bijv. <ENTER_>) aanschouwelijk gemaakt.

	<F1>: <F1_>:	Situatieafhankelijke functie (wordt op het display weergegeven) bijv.: <F1>/[Menu]: Menu voor meetinstellingen openen <F1_>/[Menu]: Menu voor systeeminstellingen openen
	<F2>: <F2_>:	
	<On/Off>:	Meettoestel in-/uitschakelen
	<M>:	Meetgrootte selecteren
	<CAL>: <CAL_>:	Kalibreermethode oproepen Kalibreergegevens weergeven
	<STO>: <STO_>:	Meetwaarde handmatig opslaan Automatische opslag configureren en starten
	<RCL>: <RCL_>:	Handmatig opgeslagen meetwaarden weergeven Automatisch opgeslagen meetwaarden weergeven
	<▲><▼>:	Menubesturing, navigatie
	<ENTER>: <ENTER_>:	Menu voor meetinstellingen openen / invoer bevestigen Menu voor systeeminstellingen openen
	<AR>:	Meetwaarde bevroren (HOLD - functie) AutoRead-meting in-/uitschakelen

Display (voorbeeld: pH-meting)

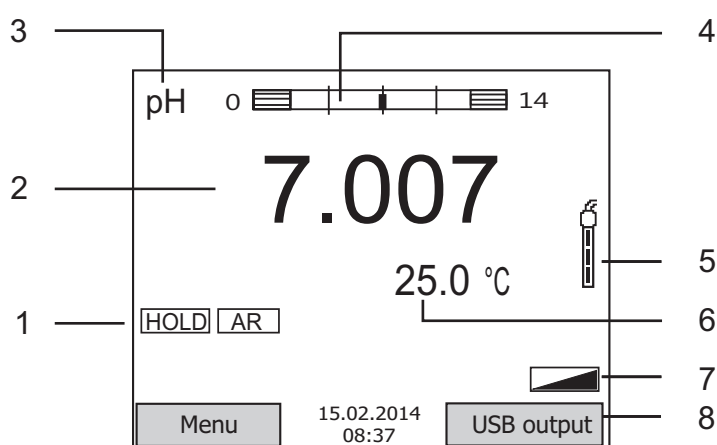

1	Statusinformatie
2	Meetwaarde (met eenheid)
3	Meetgrootte
4	Continue meetwaardecontrole (CMC-functie)
5	Sensorsymbool (kalibreerevaluatie)
6	Temperatuur-meetwaarde (met eenheid)
7	Verdere statusinformatie
8	Softkeys en datum/tijd

Bussenveld / aansluitingen

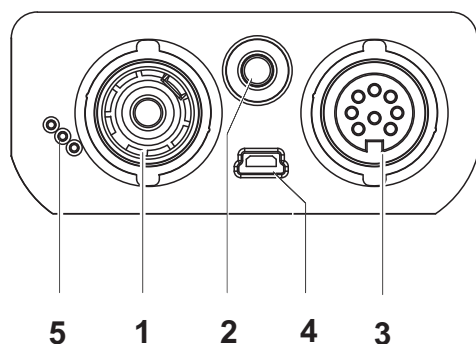

1	pH-elektrode
2	Temperatuurmeetvoeler
3	Geleidingsvermogensmeetcel, Zuurstofsensor
4	USB-B-interface (Device)
5	Service-interface

Eerste inbedrijfname

1	De meegeleverde batterijen plaatsen. Let daarbij op de juiste polariteit.
2	Meettoestel met de toets <On/Off> inschakelen.



Voorzichtig

Neem de veiligheidsaanwijzingen voor de gebruikte sensoren in acht. De handleidingen voor de sensoren vindt u op de meegeleverde cd en op internet op www.WTW.com.

Multi 3320

Oversikt







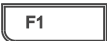

Med måleren Multi 3320 kan du utføre raske og pålitelige målinger (pH, ledeevne, oksygen).

Med måleren Multi 3320 er du sikret maksimal betjeningskomfort, pålitelighet og målenøyaktighet.

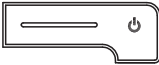
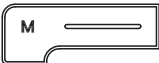
Knapper

Knappene vises av hakeparenteser <.>.

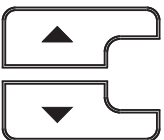
Knappsymbolet (for eksempel <ENTER>) betyr vanligvis et kort trykk på knappen (under to sekunder). Et langt knappetrykk (ca. 2 sek) vises av en strek under knappesymbolet (f.eks. <ENTER__>).

	<F1>:	Situasjonsavhengig funksjon (vises på displayet), for eksempel:
	<F1__>:	
	<F2>:	<F1>/[Menu]: Åpne menyen for måleinnstillinger
	<F2__>:	<F1__>/[Menu]: Åpne menyen for systeminnstillinger
	<On/Off>:	Slå måleren på/av
	<M>:	Velge målestørrelse
	<CAL>:	Hente frem kalibreringsprosedyren
	<CAL__>:	Vise kalibreringsdata
	<STO>:	Lagre måleverdien manuelt
	<STO__>:	Konfigurere og starte automatisk lagring
	<RCL>:	Vise manuelt lagrede måleverdier
	<RCL__>:	Vise automatisk lagrede måleverdier
	<▲><▼>:	Menystyring, navigering
	<ENTER>:	Åpne menyen for måleinnstillinger / Bekrefte inntasting
	<ENTER__>:	Åpne menyen for systeminnstillinger
	<AR>:	Fryse måleverdi (HOLD-funksjon) Slå AutoRead-måling på/av

Display (eksempel: pH-måling)

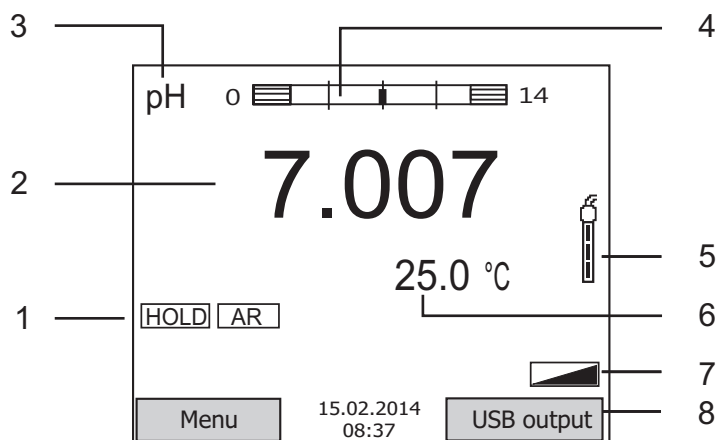

1	Statusinformasjon
2	Måleverdi (med enhet)
3	Målestørrelse
4	Kontinuerlig måleverdikontroll (CMC-funksjon)
5	Følersymbol (kalibreringsanalyse)
6	Temperaturmåleverdi (med enhet)
7	Mer statusinformasjon
8	Programtaster og dato/tid

Kontaktpanel/tilkoblinger

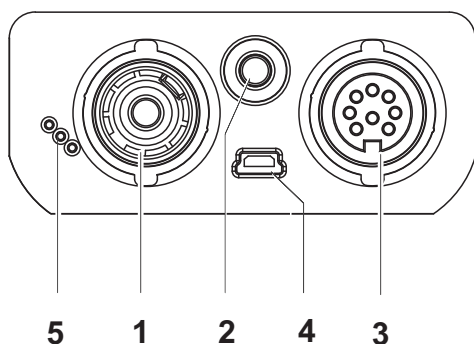

1	pH-elektrode
2	Temperaturmåleføler
3	Ledeevnmålecelle, Oksygenføler
4	USB-B-grensesnitt (Device)
5	Servicegrensesnitt

Første gangs bruk

- 1 Sett inn batteriene som fulgte med. Pass på riktig polaritet.
- 2 Slå på måleren med knappen <On/Off> .



Forsiktig

Les sikkerhetsinstruksene for følerne som brukes.

Du finner bruksanvisning for følerne på CD-platen som fulgte med og på nettsiden www.WTW.com.

Multi 3320

Informacje ogólne







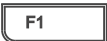

Za pomocą urządzenia pomiarowego Multi 3320 można szybko i niezawodnie wykonywać pomiary (pH, przewodności, tlenu).

Urządzenie pomiarowe Multi 3320 zapewnia najwyższy poziom komfortu obsługi, niezawodności i dokładności pomiarowej.

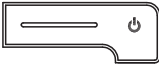
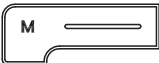
Klawiatura

Nazwy klawiszy umieszczono w nawiasach ostrokątnych <...>.

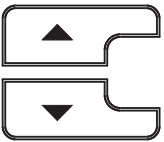
Symbol klawisza (n p. <ENTER>) oznacza zasadniczo obsługi krótkie naciśnięcie klawisza (poniżej 2 s). Długie naciśnięcie klawisza (ok. 2 s) wskazywane jest za pomocą kreski za symbolem klawisza (n p. <ENTER__>).

	<F1>:	Funkcja zależna od sytuacji (jest wyświetlana na wyświetlaczu) n p.:
	<F1__>:	
	<F2>:	
	<F2__>:	<F1>/[Menu]: Otwieranie menu ustawień pomiaru
	<On/Off>:	Włączanie/wyłączanie miernika
	<M>:	Wybór mierzonej wielkości
	<CAL>:	Uruchamianie procedury kalibracji
	<CAL__>:	Wyświetlanie danych kalibracji
	<STO>:	Ręczne zapisywanie wartości pomiaru
	<STO__>:	Konfiguracja i uruchamianie automatycznego zapisywania
	<RCL>:	Wyświetlanie zapisanych ręcznie wartości pomiarowych
	<RCL__>:	Wyświetlanie zapisanych automatycznie wartości pomiarowych
	<▲><▼>:	Sterowanie menu, nawigacja
	<ENTER>:	Otwieranie menu ustawień pomiaru/potwierdzenie wpisów
	<ENTER__>:	Otwieranie menu ustawień systemowych
	<AR>:	Wstrzymywanie wartości pomiaru (funkcja HOLD)
		Włączanie/wyłączanie pomiaru AutoRead

Wyświetlacz (przykład: pomiar pH)

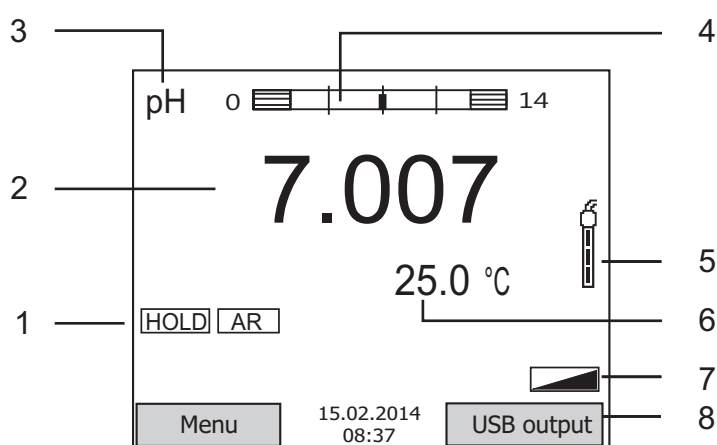

1	Informacje statusu
2	Wartość pomiaru (z jednostką)
3	Mierzona wielkość
4	Ciągła kontrola wartości pomiaru (funkcja CMC)
5	Symbol czujnika (ocena kalibracji)
6	Wartość pomiaru temperatury (z jednostką)
7	Dalsze informacje statusu
8	Przyciski programowe oraz data/godzina

Panel gniazd/przylącz

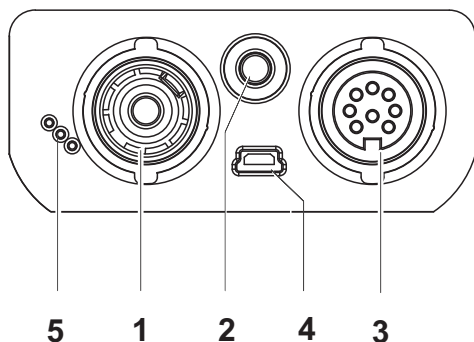

1	Elektroda pH
2	Czujnik temperatury
3	Układ pomiaru przewodności, Czujnik tlenu
4	Interfejs USB B (Device)
5	Złącze serwisowe

Uruchamianie po raz pierwszy

- 1 Włożyć załączone baterie.
Zwracać przy tym uwagę na prawidłowe ustawienie biegunów.
- 2 Włączyć miernik za pomocą klawisza <On/Off>.

**Uwaga**

Przestrzegać wskazówek bezpieczeństwa dot. stosowanych czujników. Instrukcje obsługi czujników można znaleźć na załączonym dysku CD oraz w Internecie pod adresem www.WTW.com.







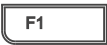

Multi 3320

Visão geral

Com o aparelho de medição Multi 3320, pode efectuar medições (pH, condutibilidade, oxigénio) de forma rápida e fiável. O aparelho de medição Multi 3320 proporciona um conforto de utilização, fiabilidade e segurança de medição máximos.

Teclado

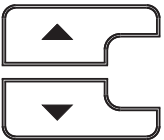
As teclas encontram-se exemplificadas através de parênteses angulares <..>. O símbolo de tecla (por ex. <ENTER>) significa geralmente uma breve pressão na tecla (menos de 2 s). Uma pressão prolongada na tecla (aprox. 2 s) encontra-se exemplificada através de um traço de sublinhado depois do símbolo de tecla (por ex. <ENTER__>).

	<F1>: <F1__>: <F2>: <F2__>:	Função consoante a situação (é apresentada no visor) p ex.: <F1>/[Menu]: Abrir menu para configurações de medição <F1__>/[Menu]: Abrir menu para configurações do sistema
		
	<On/Off>:	Ligar/desligar aparelho de medição
	<M>:	Seleccionar grandeza a medir
	<CAL>: <CAL__>:	Chamar processo de calibração Visualizar dados de calibração
	<STO>: <STO__>:	Memorizar manualmente o valor medido Configurar e iniciar a memorização automática
	<RCL>: <RCL__>:	Apresentar os valores medidos memorizados manualmente Apresentar os valores medidos memorizados automaticamente
	<▲><▼>:	Comando por menu, navegação
	<ENTER>: <ENTER__>:	Abrir menu para configurações de medição / confirmar entradas Abrir menu para configurações do sistema
	<AR>:	Congelar valor medido (função HOLD) Ligar/desligar medição AutoRead

Visor (exemplo: medição pH)

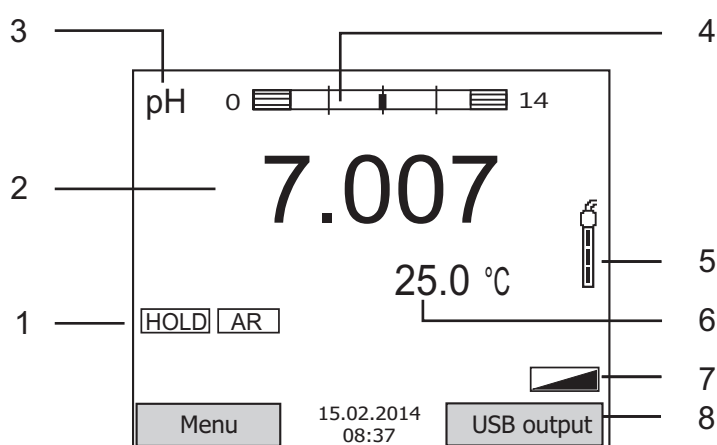

1	Informações de estado
2	Valor medido (com unidade)
3	Grandeza medida
4	Controlo contínuo do valor medido (função CMC)
5	Símbolo de sensor (avaliação da calibração)
6	Valor medido da temperatura (com unidade)
7	Outras informações de estado
8	Softkeys e data/hora

Painel de tomadas /ligações

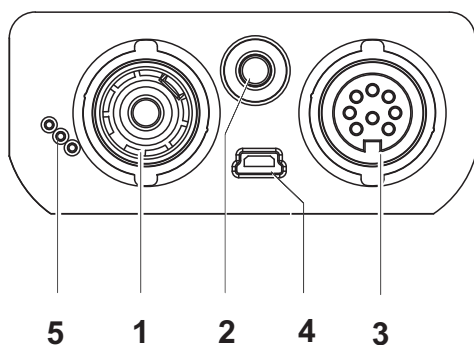

1	Eléctrodo pH
2	Sensor de medição da temperatura
3	Célula de medição da condutibilidade, Sensor de oxigénio
4	Interface USB-B (Device)
5	Interface de manutenção

Primeira colocação em funcionamento

- 1 Inserir as pilhas fornecidas juntamente com o aparelho. Aqui, tenha em atenção a polaridade correcta.
- 2 Ligar o aparelho de medição através da tecla <On/Off> .

**Atenção**

Respeite as indicações de segurança relativas aos sensores utilizados. As instruções de utilização dos sensores encontram-se no CD fornecido juntamente ou na Internet em www.WTW.com.







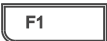

Multi 3320

Vedere de ansamblu

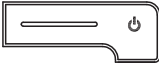
Cu instrumentul de măsură Multi 3320 puteți efectua rapid și sigur măsurători (pH, conductibilitate, oxigen). Instrumentul de măsură Multi 3320 oferă maximum de ușurință la utilizare, siguranță și precizie.

Tastatura

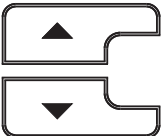
Tastele sunt reprezentate prin paranteze în unghi <.>. Simbolul tastei (de exemplu <ENTER>) semnifică în general o apăsare scurtă a tastei (mai puțin de 2 sec). O apăsare lungă a tastei (cca. 2 sec) este reprezentată printr-o liniuță după simbolul tastei (de ex. <ENTER__>).

	<F1>:	Funcție dependentă de context (este afișată pe Display) de exemplu: <F1>/[Menu]: Deschiderea meniului pentru reglarea măsurătorilor <F1__>/[Menu]: Deschiderea meniului pentru reglarea sistemului
	<F1__>:	
	<F2>:	
	<F2__>:	
	<On/Off>:	Conectarea/deconectarea instrumentului de măsură
	<M>:	Selectarea valorilor de măsurare
	<CAL>:	Accesarea procedurii de calibrare
	<CAL__>:	Afișarea datelor de calibrare
	<STO>:	Salvarea manuală a valorii măsurate
	<STO__>:	Configurarea și inițierea salvării automate
	<RCL>:	Afișarea valorilor salvate manual
	<RCL__>:	Afișarea valorilor salvate automat
	<▲><▼>:	Gestionarea meniului, navigare
	<ENTER>:	Deschiderea meniului pentru reglarea măsurătorilor / Confirmarea intrărilor
	<ENTER__>:	Deschiderea meniului pentru reglarea sistemului
	<AR>:	Blocarea valorii măsurate (funcția HOLD) Activarea / dezactivarea măsurătorii AutoRead

Display (Exemplu: măsurare pH)

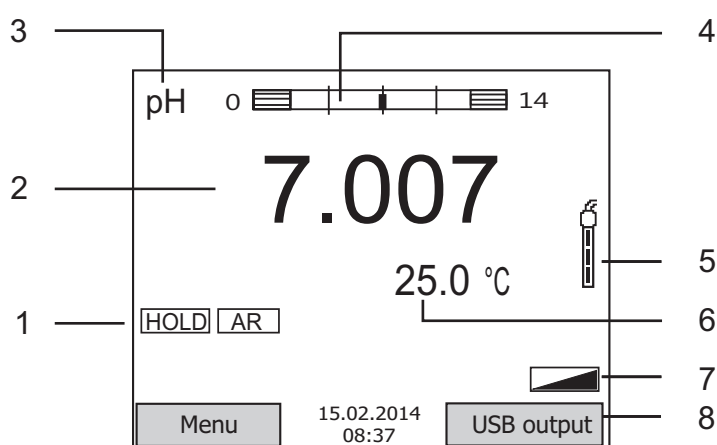

1	Informații status
2	Valoare măsurată (cu aparat)
3	Mărimea de măsurare
4	Verificarea constantă a valorilor măsurate (funcția CMC)
5	Simbolul senzorului (evaluarea calibrării)
6	Valoarea temperaturii (cu aparat)
7	Alte informații status
8	Taste funcționale și data/ora

Zona fișelor /Conexiuni

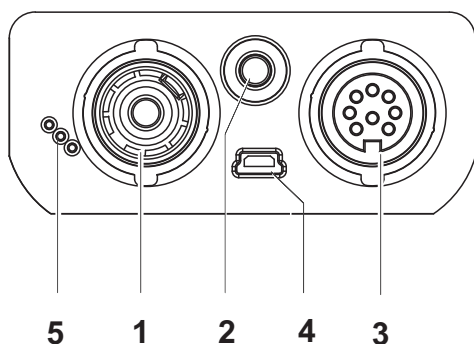

1	Electrod pH
2	Senzor de măsurare a temperaturii
3	Celula de măsurare a conductivității, Senzor de oxigen
4	Interfață USB-B (dispozitiv)
5	Interfața service

Punerea inițială în funcțiune

- 1 | Montați bateriile livrate odată cu instrumentul de măsură. Atenție la polaritate.
- 2 | Porniți instrumentul de măsură cu tasta <On/Off> .



Atenție

Respectați recomandările de siguranță pentru senzorii utilizați. Instrucțiunile de utilizare a senzorilor sunt disponibile pe CD-ul livrat cu instrumentul de măsură sau pe Internet, la adresa www.WTW.com.

Multi 3320

Обзор

Этот прибор Multi 3320 позволяет быстро и надёжно выполнить различные измерения (значение pH, проводимость растворов, содержание кислорода).

Измерительный прибор Multi 3320 обеспечивает максимум удобства, надёжности и точности в работе.

Кнопочная панель

Названия кнопок выделены угловыми скобками <..>.

Значок кнопки (например, <ENTER>) означает короткое нажатие кнопки (менее 2 с). Продолжительное нажатие кнопки (ок. 2 с) обозначается знаком подчёркивания вслед за значком кнопки (например <ENTER__>).

	<F1>: <F1__>:	Функция, зависящая от ситуации (отображается на дисплее), например: <F1>/[Menu]: Открыть меню настроек измерения <F1__>/[Menu]: Открыть меню системных настроек
	<F2>: <F2__>:	
	<On/Off>:	Включить/выключить измерительный прибор
	<M>:	Выбрать измеряемый параметр
	<CAL>: <CAL__>:	Вызвать способ калибровки Показать калибровочные данные
	<STO>: <STO__>:	Сохранить результат измерения вручную Настроить и запустить автоматическое сохранение
	<RCL>: <RCL__>:	Показать результаты измерения, сохраненные вручную Показать результаты измерения, сохраненные в автоматическом режиме
	<▲><▼>:	Управление меню, навигация
	<ENTER>: <ENTER__>:	Открыть меню настроек измерения/подтвердить ввод значений Открыть меню системных настроек
	<AR>:	Удержание результата измерения (функция HOLD) Включить/выключить измерение AutoRead

Дисплей (например: измерение pH)

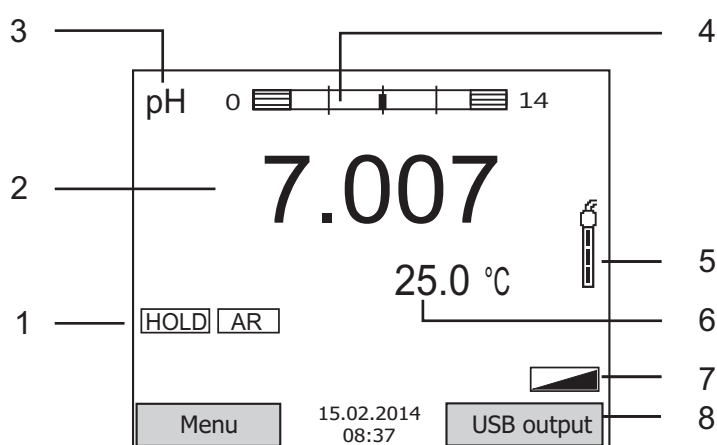

1	Информация о статусе
2	Результат измерения (с единицей измерения)
3	Измеряемый параметр
4	Непрерывный контроль результатов измерения (функция СМС)
5	Символ датчика (обработка калибровочных данных)
6	Результат измерения температуры (с единицей измерения)
7	Дополнительная информация о статусе
8	Программируемые клавиши и дата/ время

Гнёзда/разъёмы

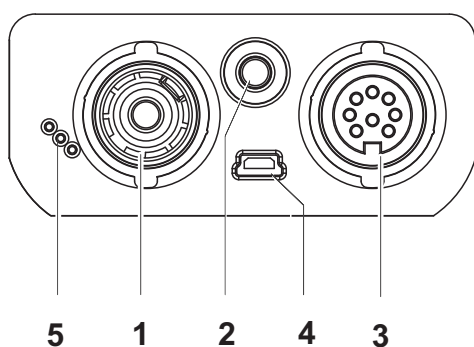

1	pH-электрод
2	Термодатчик
3	Ячейка для измерения проводимости, Датчик кислорода
4	Разъём USB-B (устройство)
5	Служебный интерфейс

Первый ввод в эксплуатацию

- 1 Вставьте батарейки (входят в комплект поставки). При установке соблюдайте полярность.
- 2 Включите прибор с помощью кнопки <On/Off>.



Осторожно

Соблюдайте указания по технике безопасности для используемых датчиков.

Руководства по эксплуатации датчиков см. на компакт-диске (входит в комплект поставки) и в интернете на www.WTW.com.

Multi 3320







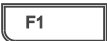

Prehľad

Meračom Multi 3320 môžete rýchlo a spoľahlivo merať (pH, vodivosť, rozpustený kyslík).
Merač Multi 3320 ponúka v maximálnej miere komfort obsluhy a ovládania, spoľahlivosť a bezpečnosť merania.

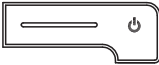
Tlačidlá

Tlačidlá sú označené špicatými zátvorkami <.>.

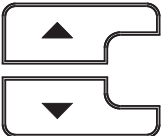
Tlačidlový symbol (napr. <ENTER>) všeobecne znamená krátke stlačenie tlačidla (kratšie než 2 s). Dlhé stlačenie tlačidla (cca 2 s) je znázornené čiarkou za symbolom tlačidla (napr. <ENTER__>).

	<F1>: <F1__>: <F2>: <F2__>:	Situačne závislá funkcia (indikuje sa na displeji), napr.: <F1>/[Menu]: Otvorenie ponuky meračských nastavení <F1__>/[Menu]: Otvorenie ponuky systémových nastavení
		
	<On/Off>:	Zapnutie/vypnutie prístroja
	<M>:	Voľba meranej veličiny
	<CAL>: <CAL__>:	Vyvolanie kalibrácie Zobrazenie kalibračných údajov
	<STO>: <STO__>:	Ručné uloženie nameranej hodnoty Nakonfigurovať a spustiť automatické ukladanie
	<RCL>: <RCL__>:	Zobrazenie ručne uložených nameraných hodnôt Zobrazenie automaticky uložených nameraných hodnôt
	<▲><▼>:	Nastavovanie a navigácia v ponukách
	<ENTER>: <ENTER__>:	Otvorenie ponuky meračských nastavení / potvrdenie zadania Otvorenie ponuky systémových nastavení
	<AR>:	Zmrazenie nameranej hodnoty (funkcia HOLD) Zapnutie / vypnutie merania s automatickým odčítaním

Displej (príklad: meranie pH)

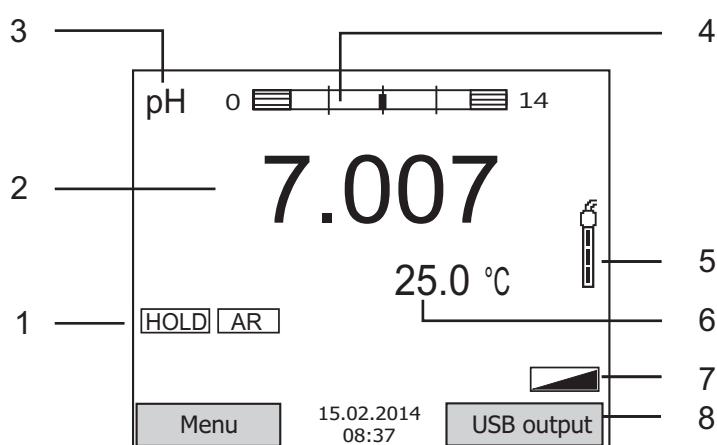

1	Stavové informácie
2	Nameraná hodnota (s jednotkou)
3	Merná veličina
4	Nepretržitá kontrola meranej veličiny (funkcia CMC)
5	Symbol senzora (vyhodnotenie kalibrácie)
6	Teplota merania (s jednotkou)
7	Ďalšie stavové informácie
8	Programovateľné funkčné tlačidlá a dátum/čas

Zásuvky / prípojky

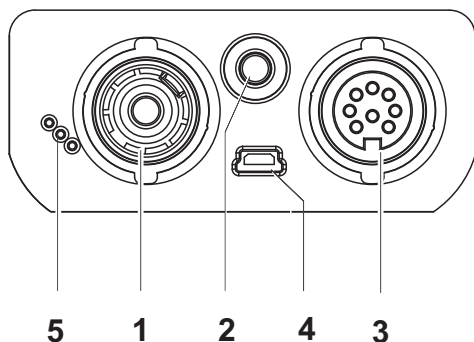

1	Elektróda pH
2	Teplotný senzor
3	Merací článok, Snímač na meranie rozpusteného kyslíka
4	Rozhranie USB-B (prístroj)
5	Servisné rozhranie

Prvé uvedenie do prevádzky

- 1 Vložte priložené batérie.
Dbajte pritom na správnu polaritu.
- 2 Zapnite merací prístroj tlačidlom <On/Off> .

**Pozor**

Dodržiavajte bezpečnostné pokyny pre použité senzory.
Návody na obsluhu senzorov nájdete na priloženom CD a na internete na adrese www.WTW.com.

Multi 3320

Översikt







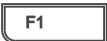

Med mätinstrumentet Multi 3320 kan du utföra mätningar (av pH, konduktans, syre) snabbt och tillförlitligt.

Mätinstrumentet Multi 3320 ger maximal manöverkomfort, tillförlitlighet och mätsäkerhet.

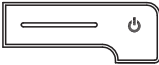
Tangentbord

Knapparna åskådliggörs med spetsiga parenteser <.>.

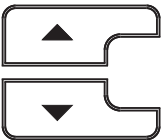
Knappsymbolen (t.ex. <ENTER>) innebär generellt en kort knapptryckning (under 2 s). En lång knapptryckning (ca. 2 s) visas genom ett streck efter knappsymbolen (t.ex. <ENTER__>).

	<F1>: <F1__>:	Situationsberoende funktion (visas på displayen)t.ex.: <F1>/[Menu]: Öppna menyn för mätinställningar
	<F2>: <F2__>:	<F1__>/[Menu]: Öppna menyn för systeminställningar
	<On/Off>:	På-/Frånslag av mätinstrumentet
	<M>:	Välja mätstorhet
	<CAL>: <CAL__>:	Öppna kalibrering Visa kalibreringsdata
	<STO>: <STO__>:	Spara mätvärde manuellt Konfigurera och starta automatiskt sparande
	<RCL>: <RCL__>:	Visa manuellt sparade mätvärden Visa automatiskt sparade mätvärden
	<▲><▼>:	Menystyrning, navigering
	<ENTER>: <ENTER__>:	Öppna menyn för mätinställningar / bekräfta inmatningar Öppna menyn för systeminställningar
	<AR>:	Frysa mätvärde (HOLD - funktion) På/Frånslag av AutoRead-mätning

Display (exempel: pH-mätning)

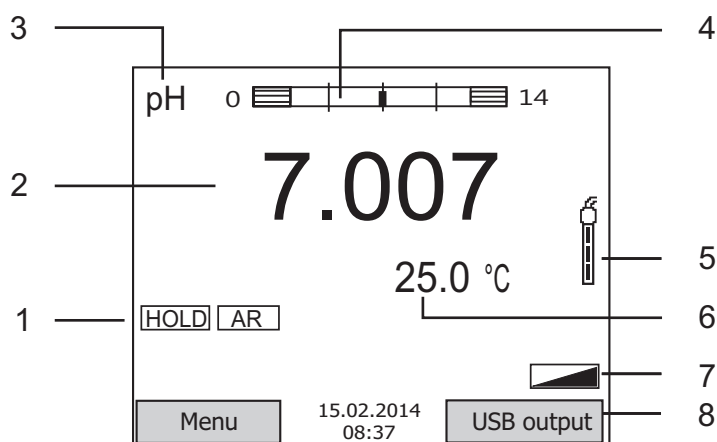

1	Statusinformation
2	Mätvärde (med enhet)
3	Mätstorhet
4	Kontinuerlig mätvärdeskontroll (CMC-funktion)
5	Givarsymbol (kalibreringsberäkning)
6	Temperaturmätvärde (med enhet)
7	Mer statusinformation
8	Softkeys och datum/tid

Portområde/anslutningar

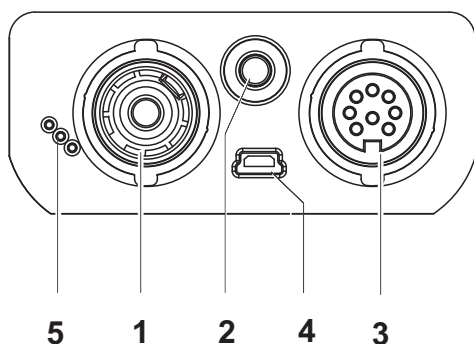

1	pH-elektrod
2	Temperaturmätgivare
3	Konduktansmätcell, Syregivare
4	USB-B-gränssnitt (Device)
5	Service-gränssnitt

Första driftsättning

- Lägg i de medföljande batterierna. Se till att de ligger åt rätt håll.
- Slå på mätinstrumentet med **<On/Off>** -knappen.



Försiktigt

Följ noga säkerhetsanvisningarna för givarna du ska använda. Bruksanvisningarna för givarna finns på medföljande CD och på Internet under www.WTW.com.

Multi 3320

Genel bakış









Multi 3320 ölçüm cihazı ile hızlı ve güvenilir ölçümler (pH, iletkenlik, oksijen) yapabilirsiniz.

Ölçüm cihazı Multi 3320 maksimum kullanım konforu, güvenilirlik ve ölçüm hassasiyeti sunar.

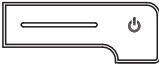
Tuş alanı

Tuşlar uçlarından görünür şekilde <.> kenetlenir.

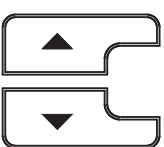
Tuş sembolü (örn. <ENTER>), genel olarak tuşa kısa bir şekilde basma anlamındadır (2 saniyeden az). Tuşa uzun basma (yaklaşık 2 saniye) tuş sembolünün altında bir çizgi (örn. <ENTER__>) ile gösterilir.

	<F1>: <F1__>:	Duruma bağlı fonksiyon (ekranda gösterilir)örn.: <F1>/[Menu]: Ölçüm ayarları için menünün açılması
	<F2>: <F2__>:	<F1__>/[Menu]: Sistem ayarları için menünün açılması
	<On/Off>:	Ölçüm cihazının açılması/kapatılması
	<M>:	Ölçülen değişkenin seçilmesi
	<CAL>: <CAL__>:	Kalibrasyon yönteminin çağrılması Kalibrasyon verilerinin gösterilmesi
	<STO>: <STO__>:	Ölçüm değerinin manuel olarak kaydedilmesi Otomatik kaydın konfigüre edilmesi ve başlatılması
	<RCL>: <RCL__>:	Manüel kaydedilen ölçüm değerlerinin görüntülenmesi Otomatik kaydedilen ölçüm değerlerinin görüntülenmesi
	<▲><▼>:	Menü kontrolü, navigasyon
	<ENTER>: <ENTER__>:	Ölçüm ayarları için menünün açılması / girişlerin onaylanması Sistem ayarları için menünün açılması
	<AR>:	Ölçüm değerinin dondurulması (HOLD - fonksiyonu) AutoRead ölçümünün açılması/kapatılması

Ekran(Örnek: pH-ölçümü)

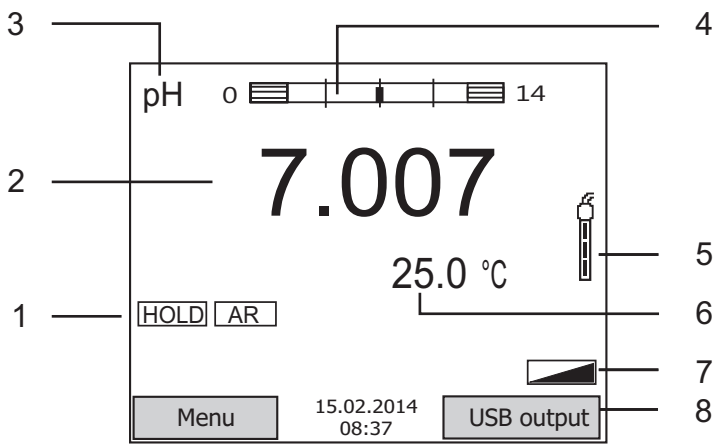

1	Durum bilgileri
2	Ölçüm değeri (birimli)
3	Ölçülen değişken
4	Sürekli ölçüm değeri kontrolü (CMC-fonksiyonu)
5	Sensör sembolü (kalibrasyon değerlendirme)
6	Sıcaklık ölçüm değeri (birimli)
7	Diğer durum bilgileri
8	Orta menü tuşları ve tarih/saat

Jak sahası /bağlantıları

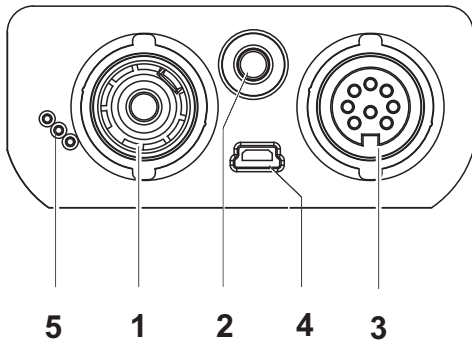

1	pH elektrodu
2	Sıcaklık ölçüm hissedicisi
3	İletkenlik ölçüm hücreleri, Oksijen sensörü
4	USB-B-arabirimi (cihaz)
5	Servis arabirimi

İlk kullanım

- 1 Beraberinde verilen piller yerleştirilmelidir. Doğru şekilde yerleştirilmesine dikkat ediniz
- 2 <On/Off> tuşu ile ölçüm cihazı açılır.

**Dikkat**

Kullanılan sensörler için güvenlik uyarılarını dikkate alınız. Sensörlere ilişkin kullanım kılavuzlarını beraberinde verilen CD'de veya internette bulabilirsiniz: www.WTW.com adresinde bulabilirsiniz.

Multi 3320

概况

使用测量仪 Multi 3320 您可以快速、可靠地进行测量 (pH 值、电导率、氧气)。测量仪 Multi 3320 具有高度的操作舒适性、可靠性和测量安全性。

按键区

按键通过尖括号 <.> 表示。

按键符号 (例如 <ENTER>) 一般表示短时间按下按键 (少于 2 秒)。较长时间按下按键 (约 2 秒) 通过按键符号后的下划线 (例如 <ENTER__>) 表示。

	<F1>: <F1__>:	与状态有关的功能 (通过显示屏显示) 例如 :
	<F2>: <F2__>:	<F1>/[Menu]: 打开测量设置菜单 <F1__>/[Menu]: 打开系统设置菜单
	<On/Off>:	接通 / 关闭测量仪
	<M>:	选择测量参数
	<CAL>: <CAL__>:	调用校准方法 显示校准数据
	<STO>: <STO__>:	手动储存测量值 设置和启动自动储存
	<RCL>: <RCL__>:	显示手动储存的测量值 显示自动储存的测量值
	<▲><▼>:	菜单操控, 导航
	<ENTER>: <ENTER__>:	打开测量设置菜单 / 确认输入 打开系统设置菜单
	<AR>:	冻结测量值 (HOLD 功能) 开启 / 关闭自动读取测量

显示屏 (例如 : pH 值测量)

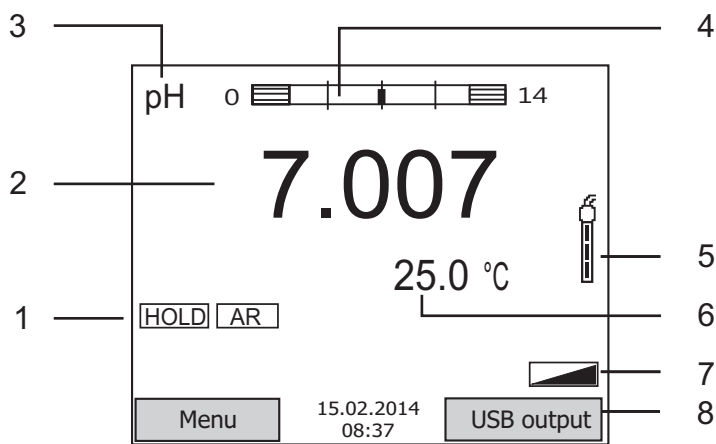

1	状态信息
2	测量值 (含单位)
3	测量参数
4	连续的测量值控制 (CMC 功能)
5	传感器图标 (校准评估)
6	温度测量值 (含单位)
7	其他状态信息
8	软键和日期 / 时间

插口区 / 接口

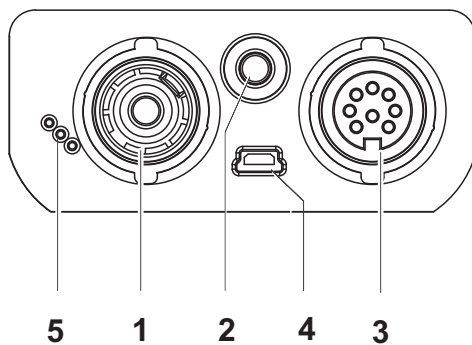

1	pH 电极
2	温度探测器
3	电导率测量仪, 氧气传感器
4	USB-B- 接口 (装置)
5	保养接口

首次使用

- 1 装入随附的电池。
同时注意蓄电池极性是否正确。
- 2 按下按键 <On/Off> 接通测量仪。



小心

注意所用传感器的安全提示。

传感器操作说明可以在随附的 CD 光盘中和互联网地址 www.WTW.com 下找到。

What can Xylem do for you?

We're a global team unified in a common purpose: creating innovative solutions to meet our world's water needs. Developing new technologies that will improve the way water is used, conserved, and re-used in the future is central to our work. We move, treat, analyze, and return water to the environment, and we help people use water efficiently, in their homes, buildings, factories and farms. In more than 150 countries, we have strong, long-standing relationships with customers who know us for our powerful combination of leading product brands and applications expertise, backed by a legacy of innovation.

For more information on how Xylem can help you, go to xyleminc.com.



Service address:

Xylem Analytics Germany
Sales GmbH & Co. KG
WTW
Dr.-Karl-Slevogt-Str. 1
82362 Weilheim
Germany

Tel.: +49 881 183-325
Fax: +49 881 183-414
E-Mail wtw.rma@xyleminc.com
Internet: www.WTW.com



Xylem Analytics Germany GmbH
Dr.-Karl-Slevogt-Str. 1
82362 Weilheim
Germany